

MEH-60 series

[Square Wave/Incremental]

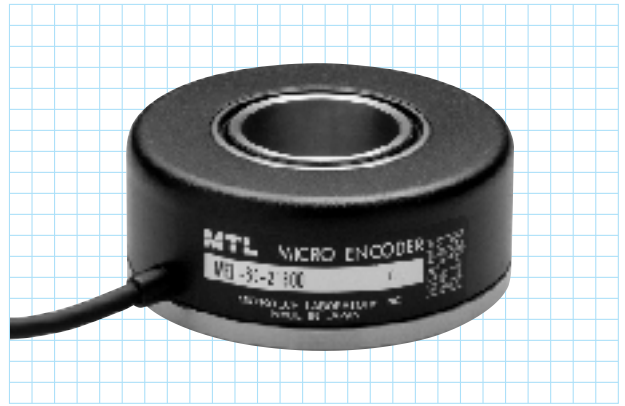

Outside dimensions

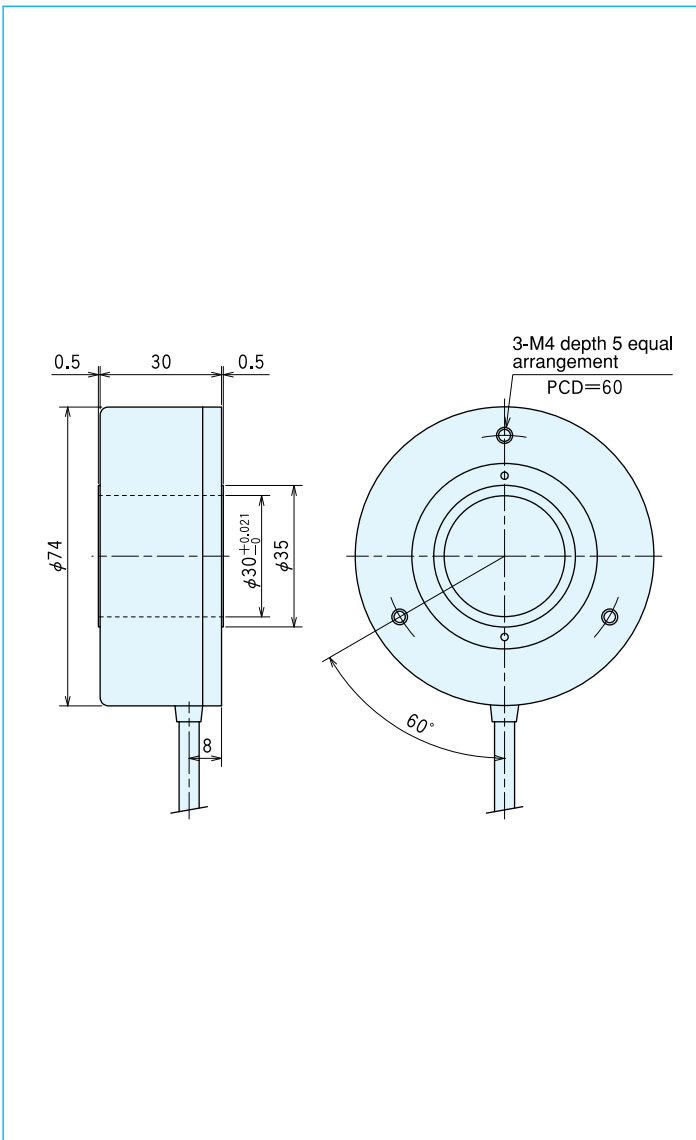

Specifications

Type name	MEH-60- <input type="text"/> <input type="text"/>																					
Item	Pulse number	Output circuit <ul style="list-style-type: none"> ● No entry=voltage output ● C=open collector output ● C4=open collector output DC24V ● S=line driver output ● S=sine wave output ● ST=built-in multiplication circuit ● P2=Two head detection 																				
Supply voltage	DC5~12V $\pm 10\%$ (* 5V fixed) DC24V $\pm 10\%$ (option)																					
Current consumption	60mA or less *120mA or less(under no load)																					
Detection system	Incremental																					
Output	Output pulse number (Standard)	<table border="1"> <tr> <td>180</td> <td>600</td> <td>1,800</td> <td>10,000</td> </tr> <tr> <td>200</td> <td>1,000</td> <td>2,000</td> <td>10,800</td> </tr> <tr> <td>360</td> <td></td> <td>4,000</td> <td>*20,250</td> </tr> <tr> <td>400</td> <td></td> <td>5,000</td> <td>*21,600</td> </tr> <tr> <td>500</td> <td></td> <td>5,400</td> <td>9,000</td> </tr> </table>	180	600	1,800	10,000	200	1,000	2,000	10,800	360		4,000	*20,250	400		5,000	*21,600	500		5,400	9,000
	180	600	1,800	10,000																		
	200	1,000	2,000	10,800																		
	360		4,000	*20,250																		
	400		5,000	*21,600																		
500		5,400	9,000																			
Output phase	A, B, Z phase																					
Output form	Square wave																					
Output capacity	Sink current: 20mA Residual voltage: 0.5V or less (at 10mA)																					
Maximum response frequency (response pulse number)	100kHz In case of voltage output, load resistance shall be 2.2k Ω . (Refer to the output circuit diagram.)																					
Output phase difference	A, B phase difference $90^\circ \pm 45^\circ$ (T/4 \pm T/8) Z phase T \pm T/2 (see Output Waveform)																					
Waveform rise/fall time	2 μ s or less (output cable 1m or less)																					
Starting torque	20 $\times 10^{-3}$ N \cdot m(200gf \cdot cm) or less(no oil seal)																					
Allowable load of shaft (electrical)	Radial	19.6N (2kgf) 9.8N (1kgf)																				
	Thrust	9.8N (1kgf) 4.7N (0.5kgf)																				
Maximum allowable revolutions (mechanical)	3,000r/min																					
Working ambient temperature/humidity	0 $^\circ$ C~60 $^\circ$ C RH35%~90% no dewing																					
Storing ambient temperature	-20 $^\circ$ C~80 $^\circ$ C																					
Vibration resistance	Durability 55Hz, double amplitude 1.5mm 2 hours each in X, Y, and Z directions																					
Impact resistance	Durability 500m/s 2 (about 50G) 3 times each in X, Y, and Z directions																					
Cable	Outside diameter ϕ 4.2 5-core vinyl wire Insulated shield cable (length 1m)																					
Mass	320g *430g																					

Note) Electrically divided

Output circuit diagram

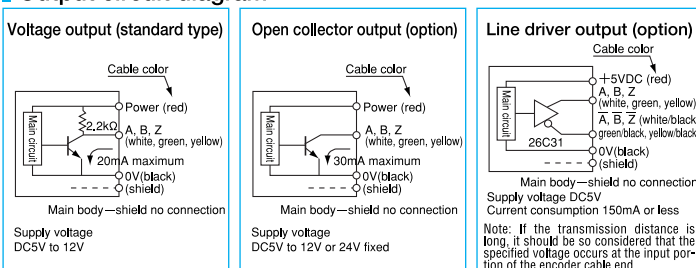

A capacitor (0.1 μ F) is connected between 0V and FG (frame ground).

Output waveform

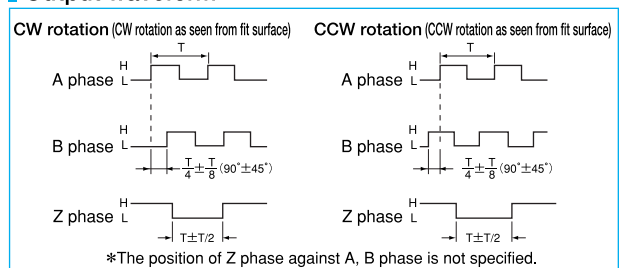

*The position of Z phase against A, B phase is not specified.

Specifications/Sine wave

Supply voltage	DC5V ±5%	
Current consumption	40mA or less (under no load)	
Detection system	Sine wave·Incremental	
Output	Output pulse number (Standard)	5,000 10,000 9,000 ※20,250 ※21,600
	[Pulse number/rotation]	
	Output phase	A, B, Z phase
	Output form	A, B phase SIN wave, Z phase square wave
	A, B, Z phase output	SIN wave 1.5 V _{p-p} ±0.3 V offset 2.0V±0.2V Opamp output current 5mA Max. Harmonic distortion factor to be within 10% (Measuring condition to be within 20 kHz, effective value mean distortion factor measuring instrument)
	Maximum response frequency	50kHz
Output phase difference	A, B phase difference 90°±45° (T/4±T/8) Z phase T±T/2 (see Output Waveform)	
Starting torque	20×10 ⁻³ N·m (200gf·cm) or less	
Allowable load of shaft (electrical)	Radial	9.8N (1kgf)
	Thrust	4.9N (0.5kgf)
Maximum allowable revolutions (mechanical)	3,000r/min	
Working ambient temperature/humidity	0°C~50°C RH35%~90% no dewing	
Storing ambient temperature	-20°C~80°C	
Vibration resistance	Durability 55Hz, double amplitude 1.5mm 2 hours each in X, Y, and Z directions	
Impact resistance	Durability 500m/s ² (about 50G) 3 times each in X, Y, and Z directions	
Cable	Outside diameter φ4.2 5-core vinyl wire Insulated shield cable (length 1m)	
Mass	320g ※430g	

Output circuit diagram

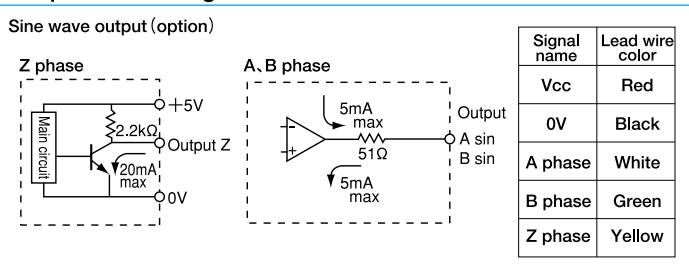

A capacitor (0.1 μF) is connected between 0V and FG (frame ground).

Output waveform

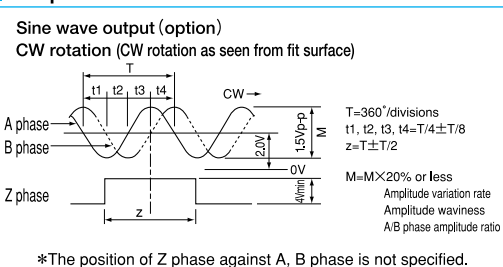

Specifications Built-in multiplication circuit (X2·X4·X8·X16)

Supply voltage	Voltage:DC5V-5%~12V+10% Open collector:DC5V-5%~24V+10% Open collector output:20,250, 21,600:DC5V-5% Line driver:DC5V±5%	
Current consumption	80mA or less (under no load)	
Detection system	Incremental	
Output	Output pulse number (Standard)	EX 21,600×2 (43,200) 21,600×4 (86,400) 21,600×8 (172,800) 21,600×16 (345,600)
	[Pulse number/rotation]	
	Output phase	A, B, Z phase
	Output form	Square wave
	Maximum response frequency	Line driver output:50kHzX (by multiplication) Voltage output·Open collector output:100kHz
Output phase difference	See the diagram below.	
Starting torque	20×10 ⁻³ N·m (200gf·cm) or less	
Allowable load of shaft (electrical)	Radial	9.8N (1kgf)
	Thrust	4.9N (0.5kgf)
Maximum allowable revolutions (mechanical)	3,000r/min	
Working ambient temperature/humidity	-10°C~70°C RH35%~90% no dewing	
Storing ambient temperature	-20°C~80°C	
Vibration resistance	Durability 55Hz, double amplitude 1.5mm 2 hours each in X, Y, and Z directions	
Impact resistance	Durability 500m/s ² (about 50G) 3 times each in X, Y, and Z directions	
Cable	Outside diameter φ4.2 5-core vinyl wire Insulated shield cable (length 1m)	
Mass	430g	

Output circuit diagram

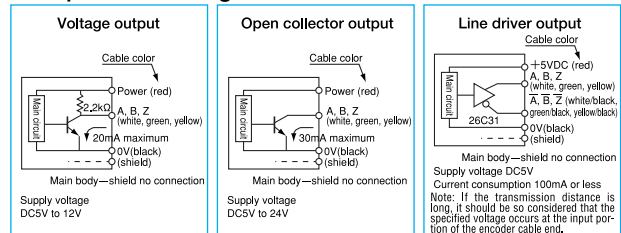

A capacitor (0.1 μF) is connected between 0V and FG (frame ground).

Output waveform

